

MA4

series



Product Segments

• Industrial Motion

TiMOTION's MA4 series electric linear actuator was specifically designed for heavy-duty applications and harsh working environments that require durability. Applications suitable for the MA4 include agricultural equipment such as fertilizer, seed spreader, harvesters, grain handlers, combines, tractors...etc. Also, commercial and industrial applications include commercial lawn mowers, scrubbers, sweepers, and material handling equipment.

Furthermore, the MA4 has an optional T-Smart (note 1) version, which can work with the PGMA (note 2) to achieve the following functionality:

- Set up the actuator's stroke and speed
- Multiple signal feedbacks support
- Monitor real-time actuator status
- Up to 8 actuator synchronization
- Built-in safety mechanism
- Customized service for BUS required applications (note 3)

Note 1: TiMOTION develops T-Smart functionality. With T-Smart, the actuator has a built-in circuit board with a microprocessor that can operate the actuator without a control box.

Note 2: PGMA is a software program developed by TiMOTION. Users can install this programmer into the laptop and adjust the actuator parameters directly.

Note 3: Please contact your local sales department for further assistance.

General Features

Max. load	2,000N (push/pull)
Max. speed at max. load	5.5mm/s
Max. speed at no load	43mm/s
Retracted length	≥ 215mm (depending on chosen options)
IP rating	IP69K
Stroke	25~1000mm
Output signals	Adjustable reed switch, mechanical POT, Hall sensor(s)
Options	T-Smart
Voltage	12/24V DC; 12/24V DC (thermal control)
Operational temperature range	-40°C~+85°C
Operational temperature range at full performance	+5°C~+45°C

Drawing

Standard Dimensions
(mm)

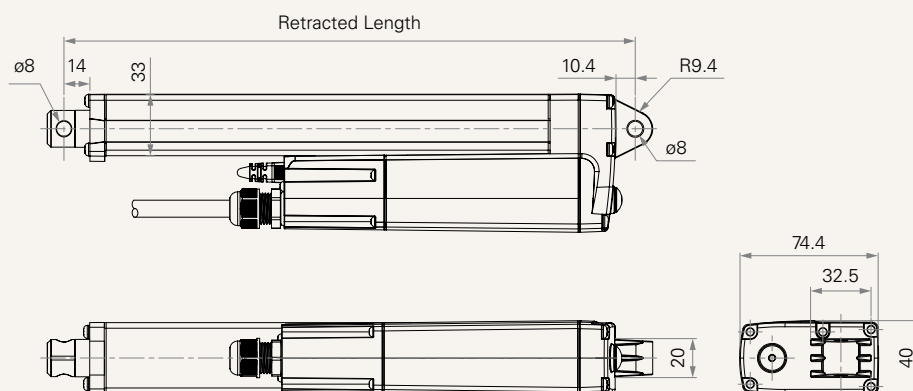

Load and Speed

CODE	Load (N)		Self Locking Force (N)	Typical Current (A)		Typical Speed (mm/s)	
	Push	Pull		No Load 24V DC	With Load 24V DC	No Load 24V DC	With Load 24V DC
Motor Speed (6000RPM, Duty Cycle 25%)							
A	250	250	325	0.7	1.4	43.0	36.5
B	500	500	650	0.6	1.9	27.5	23.0
C	1000	1000	1300	0.6	2.1	14.0	10.5
D	1500	1500	1950	0.6	2.3	9.0	7.0
E	2000	2000	2600	0.6	2.6	7.0	5.5

Note

- 1 Please refer to the approved drawing for the final authentic value.
- 2 The current & speed in table are tested with 24V DC motor. With a 12V DC motor, the current is approximately twice the current measured in 24V DC. With a 36V DC motor, the current is approximately two-thirds the current measured in 24V DC. With a 48V DC motor, the current is approximately half the current measured in 24V DC. Speed will be similar for all the voltages.
- 3 The current & speed in table are tested when the actuator is extending under push load.
- 4 With load, noise level ≤ 78 dBa (by TiMOTION test standard, ambient noise level ≤ 36 dBa).
- 5 Standard stroke: Min. 25mm, Max. please refer to below table.

CODE	Load (N)	Max Stroke (mm)
A	≤ 250	1000
B	≤ 500	800
C	≤ 1000	600
D	≤ 1500	500
E	≤ 2000	450

Performance Data (24V DC Motor)

Motor Speed (6000RPM)

Speed vs. Load

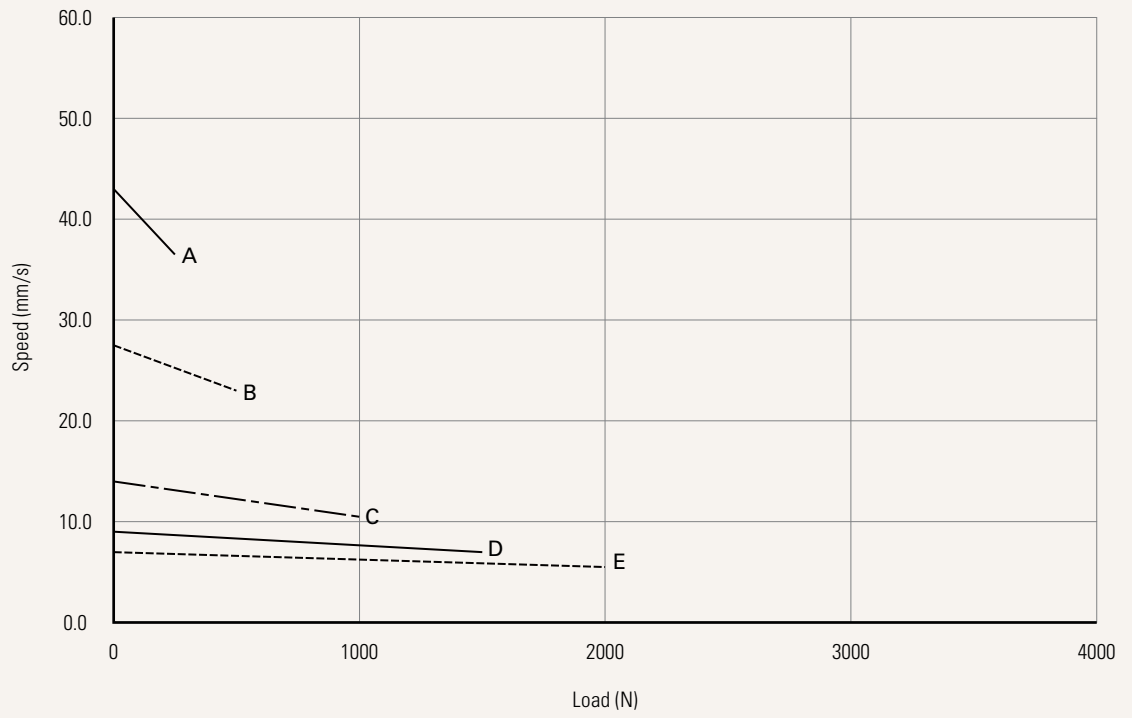

Current vs. Load

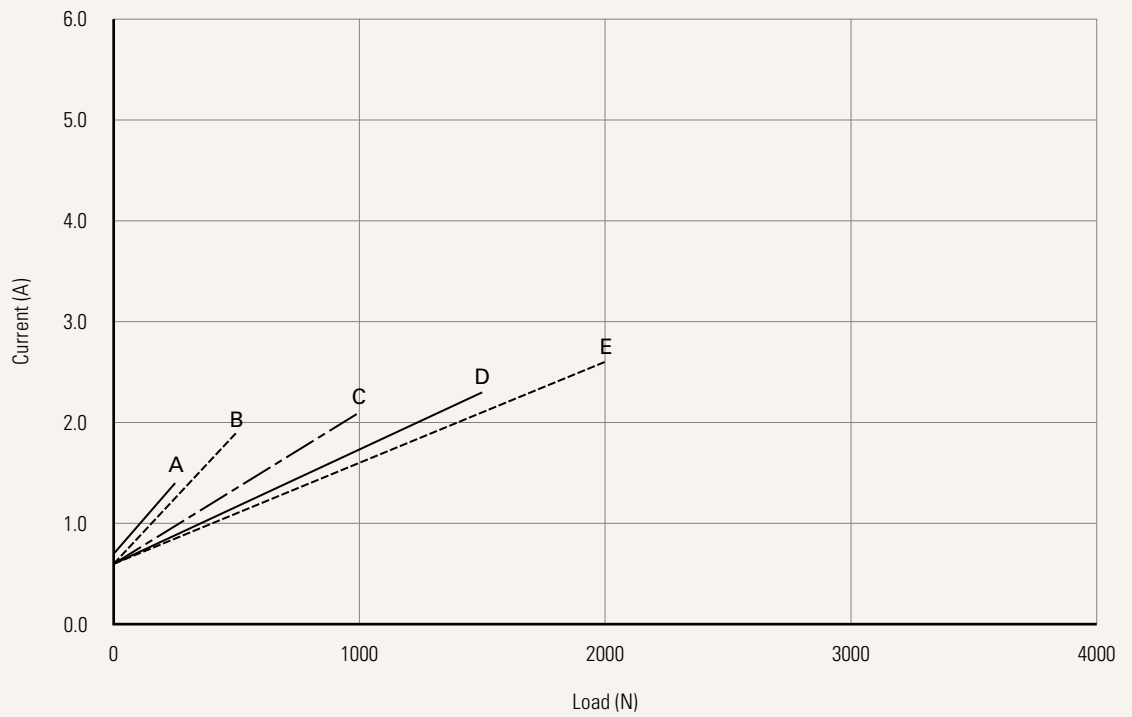

Hardware System	N = Without driver board T = Standard driver board			
Voltage	1 = 12V DC 2 = 24V DC	6 = 12V DC, thermal cutoff 5 = 24V DC, thermal cutoff		
Load & Speed	See page 2			
Stroke (mm)	See page 2			
Installation Length (mm)	See page 5			
Rear Attachment (mm)	1 = Aluminum, slotless, hole 6.4 2 = Aluminum, slotless, hole 8.0 See page 6 3 = Aluminum, slotless, hole 10.0	4 = Aluminum, U clevis, slot 6.1, depth 10.5, hole 6.4 5 = Aluminum, U clevis, slot 6.1, depth 10.5, hole 8.0 6 = Aluminum, U clevis, slot 6.1, depth 10.5, hole 10.0		
Front Attachment (mm)	1 = Aluminum, slotless, hole 6.4 2 = Aluminum, slotless, hole 8.0 See page 6 3 = Aluminum, slotless, hole 10.0	4 = Aluminum, U clevis, slot 6.1, depth 16.0, hole 6.4 5 = Aluminum, U clevis, slot 6.1, depth 16.0, hole 8.0 6 = Aluminum, U clevis, slot 6.1, depth 16.0, hole 10.0		
Installation Direction (Counter-Clockwise)	1 = 0°	3 = 90°		
See page 7				
Functions for Built-in Limit Switches at End of Stroke	1 = Two limit switches cut off the actuator at end of stroke 2 = Two limit switches send signal at end of stroke (signal type: normally closed)			
Adjustable Reed Switch	0 = Without 1 = Reed switch*1, tinned leads	2 = Reed switch*2, tinned leads		
Position Feedback	0 = Without	1 = Mechanical POT	4 = Hall sensor*1	5 = Hall sensor*2
See page 8				
IP Rating	1 = Without 6 = IP66M	7 = IP67 8 = IP68	9 = IP69K	
Cable Exit	T = T-Smart 1+1			
P1 Connector (mm)	01 = Tinned leads, unsheathed wire 50, stripped wire			
See page 7				
P1 Cable Length (mm)	0000 = Without cable 0500 = 500	1000 = 1000 1500 = 1500	2000 = 2000	
P2 Connector	0P = Rubber plug			
P2 Cable Length (mm)	0000 = Without cable			
Bus Interface	C = CAN bus			
Packaging (mm²)	0 = Sample packaging C = Standard package, US fumigated pallet (1219*1016 ²) 1 = Standard package, EU fumigated pallet (1200*800 ²) 2 = Standard package, EU fumigated pallet (1500*800 ²) E = Standard package, US plywood pallet (1219*1016 ²) 5 = Standard package, EU plywood pallet (1200*800 ²) 6 = Standard package, EU plywood pallet (1500*800 ²)			

Retracted Length (mm)

1. If stroke $\leq 108\text{mm}$, minimum retracted length refer to the chart below

Front Attach.	Rear Attach.	
	1, 2, 3	4, 5, 6
1, 2, 3	215	215
4, 5, 6	228	228

2. If Stroke $\geq 109\text{mm}$, Calculate $A+B+C=Y$

3. Minimum retracted length is Stroke+Y

A.		
Front Attach.	Rear Attach.	
	1, 2, 3	4, 5, 6
1, 2, 3	+106	+106
4, 5, 6	+119	+119

B.	
Stroke (mm)	Load & Speed Type (N)
	A, B, C, D, E
25~150	-
151~200	+2
201~250	+2
251~300	+2
301~350	+12
351~400	+22
401~450	+32
451~500	+42
501~550	+52
551~600	+62
601~650	+72
651~700	+82
701~750	+92
751~800	+102
801~850	+112
851~900	+122
901~950	+132
951~1000	+142

C.	
Output Signal	
0, 4, 5, T	-
1	+18

Rear Attachment (mm)

1 = Aluminum, slotless, hole 6.4

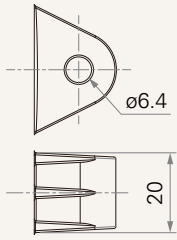

2 = Aluminum, slotless, hole 8.0

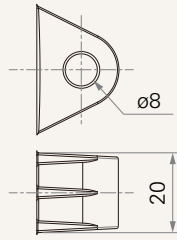

3 = Aluminum, slotless, hole 10.0

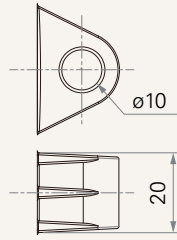

4 = Aluminum, U clevis, slot 6.1, depth 10.5, hole 6.4

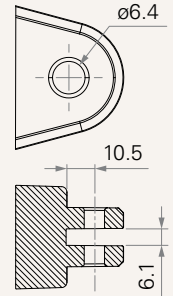

5 = Aluminum, U clevis, slot 6.1, depth 10.5, hole 8.0

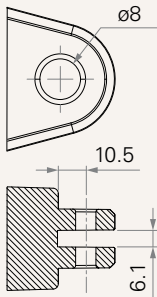

6 = Aluminum, U clevis, slot 6.1, depth 10.5, hole 10.0

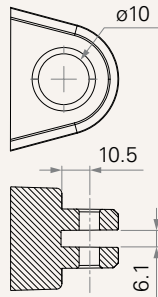

Front Attachment (mm)

1 = Aluminum, slotless, hole 6.4

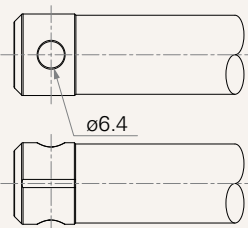

2 = Aluminum, slotless, hole 8.0

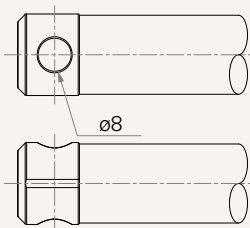

3 = Aluminum, slotless, hole 10.0

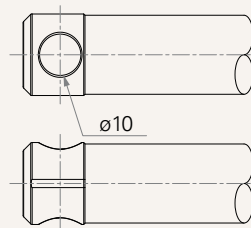

4 = Aluminum, U clevis, slot 6.1, depth 16.0, hole 6.4

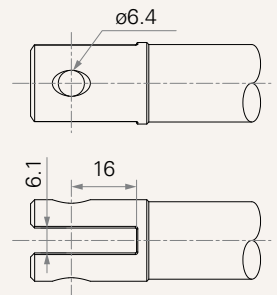

5 = Aluminum, U clevis, slot 6.1, depth 16.0, hole 8.0

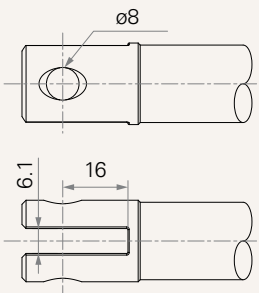

6 = Aluminum, U clevis, slot 6.1, depth 16.0, hole 10.0

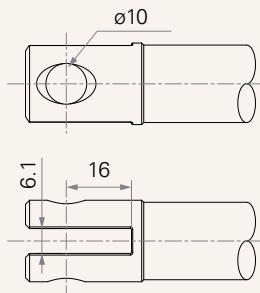

Installation Direction (Counter-Clockwise)

1 = 0°

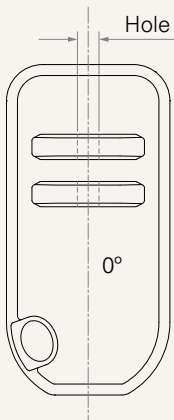

3 = 90°

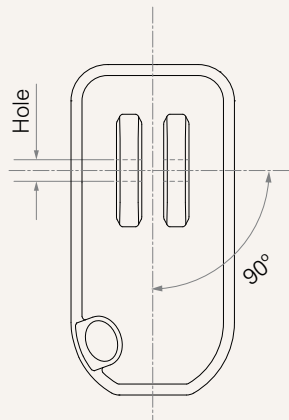

P1 Connector (mm)

01 = Tinned leads, unsheathed wire
50, stripped wire

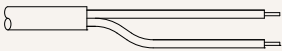

Output Signals

Wire Definitions			Wire Gauge (AWG)	Output Signal Code				
				0. Without	1. POT	4. 1 Hall	5. 2 Hall	
without T-Smart	P1	Limit Switches Cut Off the Acuator	Red	20	EXT+	V-out	+5V	+5V
			Black	20	RET+	V-in	S1	S1
			Red	26	-	-	-	S2
			White	26	-	GND	GND	GND
			Blue	26	-	-	-	-
			Black	26	-	-	-	-
			Brown	26	-	-	-	-
			Orange	26	-	-	-	-
			Purple	26	-	-	-	-
without T-Smart	P1	Limit Switches Send Signal	Red	20	EXT+	EXT+	EXT+	EXT+
			Black	20	RET+	RET+	RET+	RET+
			Red	26	COM	COM	+5V	+5V
			White	26	EOS-extended	EOS-extended	S1	S1
			Blue	26	EOS-retracted	EOS-retracted	-	S2
			Black	26	-	GND	GND	GND
			Brown	26	-	V-in	EOS-extended	EOS-extended
			Orange	26	-	V-out	EOS-retracted	EOS-retracted
			Purple	26	-	-	COM	COM

Wire Definitions			Wire Gauge (AWG)
T-Smart	P1	T-Smart	Red 20 V DC+
			Black 20 V DC-
			Brown 26 Ctrl EXT
			Gray 26 Ctrl RET
			Orange 26 EOS-extended
			Yellow 26 EOS-retracted
			Black 26 Signal ground
			White 26 S1 / POT / CAN+
			Blue 26 S2 / PWM / CAN-
T-Smart	P2	T-Smart	Molex 6p socket for TAD1 / Reed switch assembly

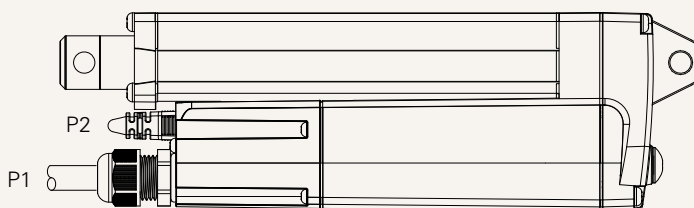

Terms of Use

The user is responsible for determining the suitability of TiMOTION products for a specific application. TiMOTION products are subject to change without prior notice.