

TA29AC

series

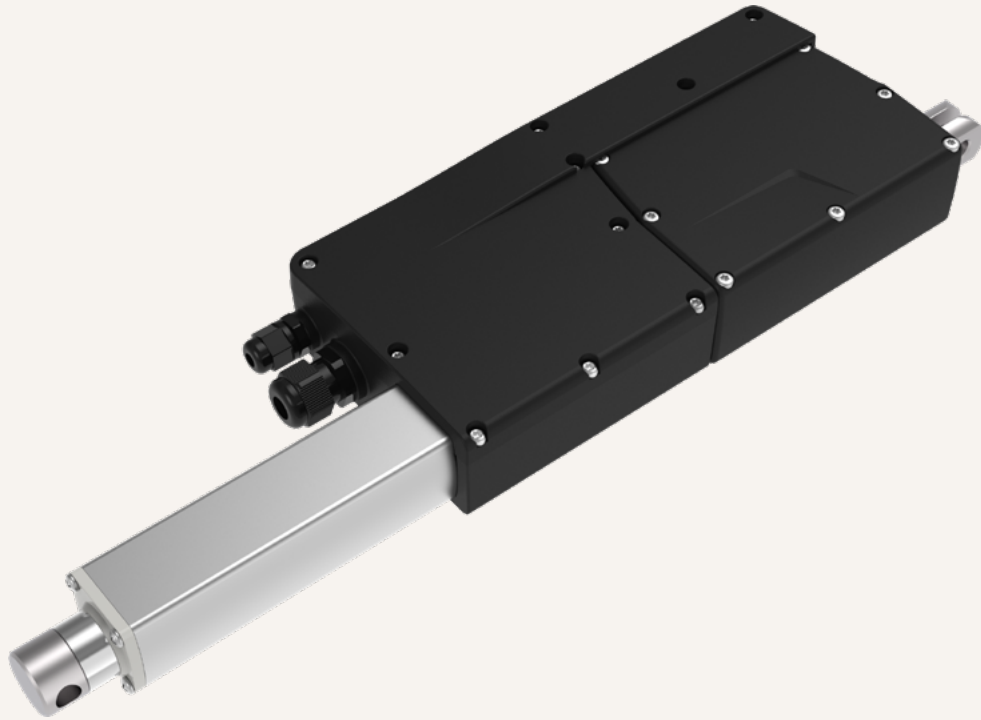

Product Segments

- **Industrial Motion**

TiMOTION's TA29AC is a linear actuator with an AC/DC power supply integrated into the housing that affords a maximum 4000N force (push/pull). It is controlled by 1 neutral wire and 2 line wires (extension and retraction), making it a powerfully practical means to automate the ventilation system in livestock farming.

General Features

Max. load	4,000N (push/pull)
Max. speed at max. load	4.5mm/s
Max. speed at no load	5.5mm/s
Retracted length	> 302mm (depending on chosen options)
IP rating	IP66W
Stroke	25~600mm
Output Signals	POT
Voltage	110~240V AC
Color	Black, grey
Operational temperature range	+5°C~+45°C

Drawing

Standard Dimensions
(mm)

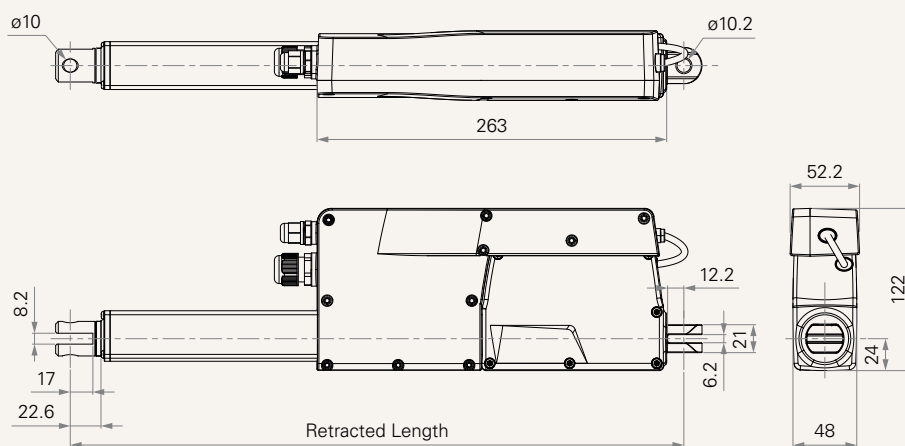

Load and Speed

CODE	Load (N)		Self Locking Force (N)	Typical Current (A)		Typical Speed (mm/s)	
	Push	Pull		No Load	With Load	No Load	With Load
220V AC							

Motor Speed (5200RPM, Duty Cycle 10%)

N	4000	4000	4000	0.4	1.2	5.5	4.5
----------	------	------	------	-----	-----	-----	-----

Note

- 1 Please refer to the approved drawing for the final authentic value.
- 2 Operational temperature range at full performance: +5°C~+45°C
- 3 The current & speed in table are tested when the actuator is extending under push load.
- 4 Standard stroke: Min. ≥ 25 mm, Max. please refer to below table.

CODE	Load (N)	Max Stroke (mm)
N	≤ 4000	600

Performance Data (220V AC Motor)

Motor Speed (5200RPM)

Speed vs. Load

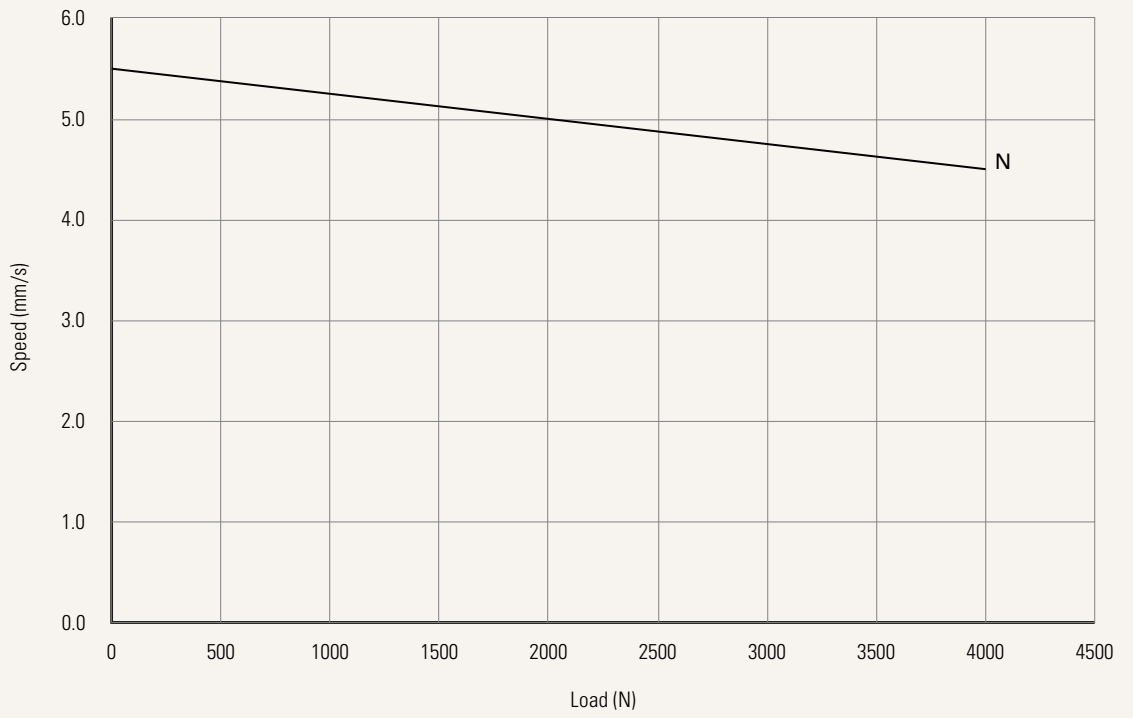

Current vs. Load

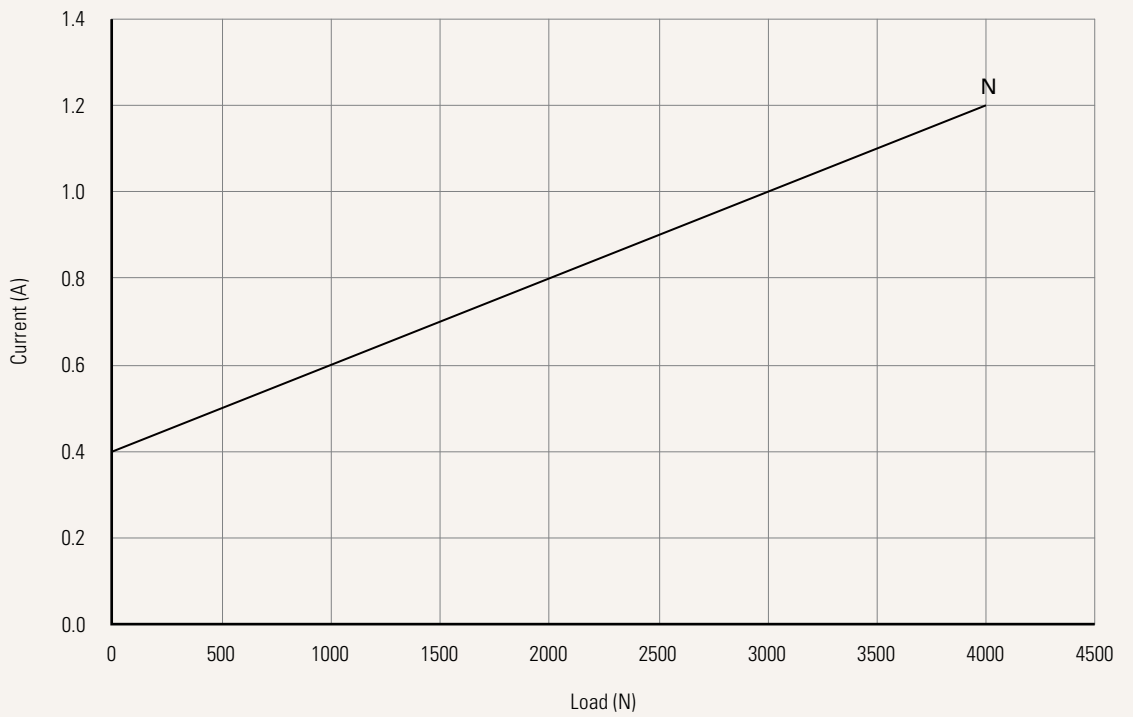

Voltage	U = 110-240V AC			
Load and Speed	See page 2			
Stroke (mm)	See page 2			
Retracted Length (mm)	See page 5			
Rear Attachment (mm)	3 = Aluminum, U clevis, slot 6.2, depth 12.2, hole 10.2		4 = Aluminum, U clevis, slot 6.2, depth 12.2, hole 12.2	
	See page 6			
Front Attachment (mm)	3 = Aluminum, slotless, hole 10.2		4 = Aluminum, slotless, hole 12.2	
	See page 6			
Direction of Rear Attachment (Counterclockwise)	1 = 90°		2 = 0°	
	See page 6			
Color	1 = Black		2 = Pantone 428C	
IP Rating	1 = Without	2 = IP54	3 = IP66	5 = IP66W
Special Functions for Spindle Sub-Assembly	0 = Without (Standard)		2 = Standard push only	
Functions for Limit Switches	1 = Two switches at full retracted / extended positions to cut current			
	See page 7			
Output Signals	0 = Without		1 = POT	
	See page 7			
Connector	2 = Tinned leads			
	See page 7			
Cable Length (mm)	Straight, 100	Straight, 750	Straight, 1250	Straight, 2000
	Straight, 500	Straight, 1000	Straight, 1500	

Retracted Length (mm)

1. Calculate $A+B+C+D = Y$
2. Retracted length needs to $\geq \text{Stroke}+Y$
3. Retracted length needs to $> 302\text{mm}$

A.

Front Attach.	Rear Attach.
	3, 4
3, 4	+112

B.

Stroke (mm)	Load (N)
	4000
25~150	+10
151~200	+18
201~250	+18
251~300	+23
301~350	+23
351~400	+28
401~450	+33
451~500	+38
501~550	+43
551~600	+48

C. Special Bunctions for Spindle Sub-Assembly

0	-
2	+6

D. Output Signal

0	-
1	+20

Rear Attachment (mm)

3 = Aluminum, U clevis, slot 6.2, depth 12.2, hole 10.2

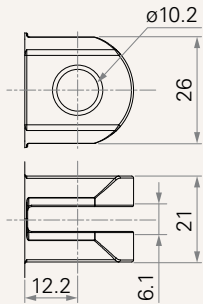

4 = Aluminum, U clevis, slot 6.2, depth 12.2, hole 12.2

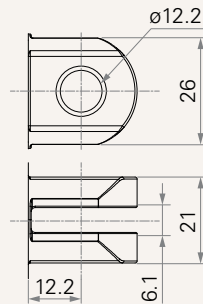

Front Attachment (mm)

3 = Aluminum, slotless, hole 10.2

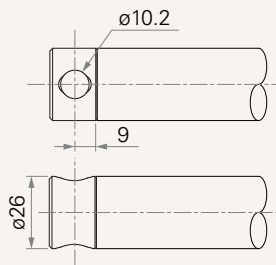

4 = Aluminum, slotless, hole 12.2

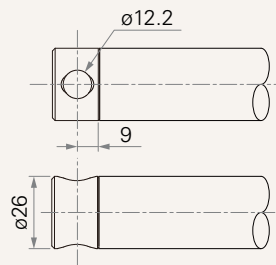

Direction of Rear Attachment (Counterclockwise)

1 = 90°

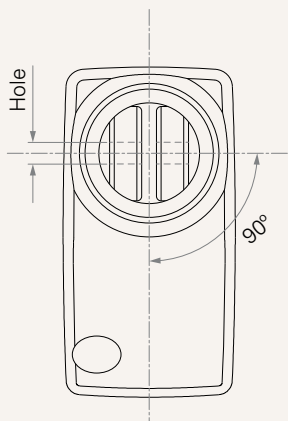

2 = 0°

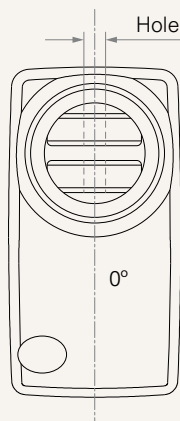

Wire Definition

Without T-Smart

Port Number	Functions for Limit Switches	Wire Color	Wire Gauge (AWG)	Position Feedback	
				0. Without	1. POT
P1 (Power)	Limit switches cut off the acuator	● Black	18	Live (EXT+)	Live (EXT+)
		○ White	18	Live (RET+)	Live (RET+)
		● Green	18	Neutral	Neutral
P2 (POT)	Limit switches cut off the acuator	○ White	26	-	V-in
		● Grey	26	-	V-out (signal)
		● Brown	26	-	GND

Connector

2 = Tinned leads

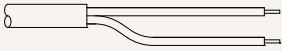

Terms of Use

The user is responsible for determining the suitability of TiMOTION products for a specific application. TiMOTION products are subject to change without prior notice.